

WEST ELEVATION

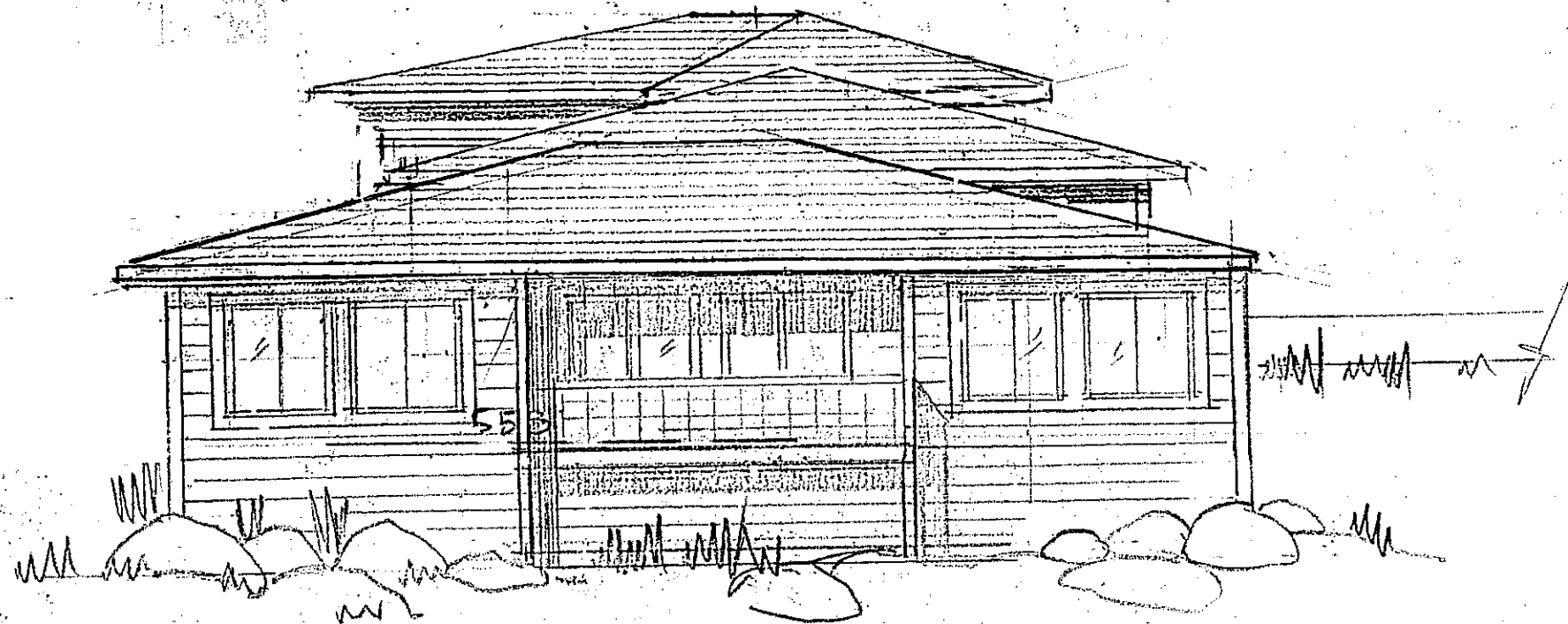

WEST ELEVATION

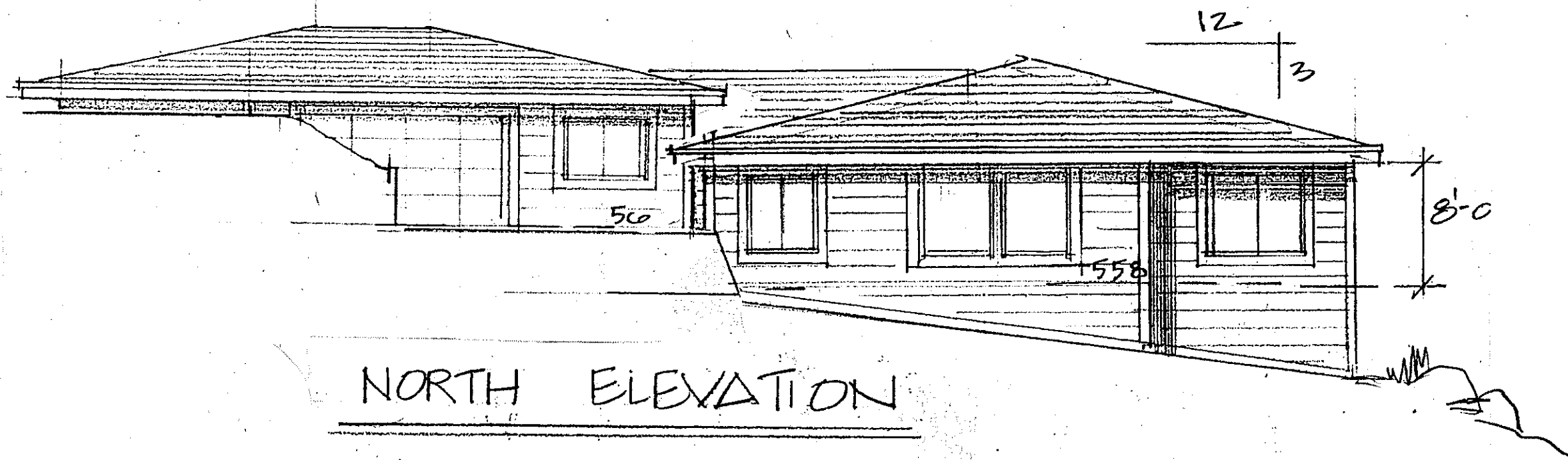

NORTH ELEVATION

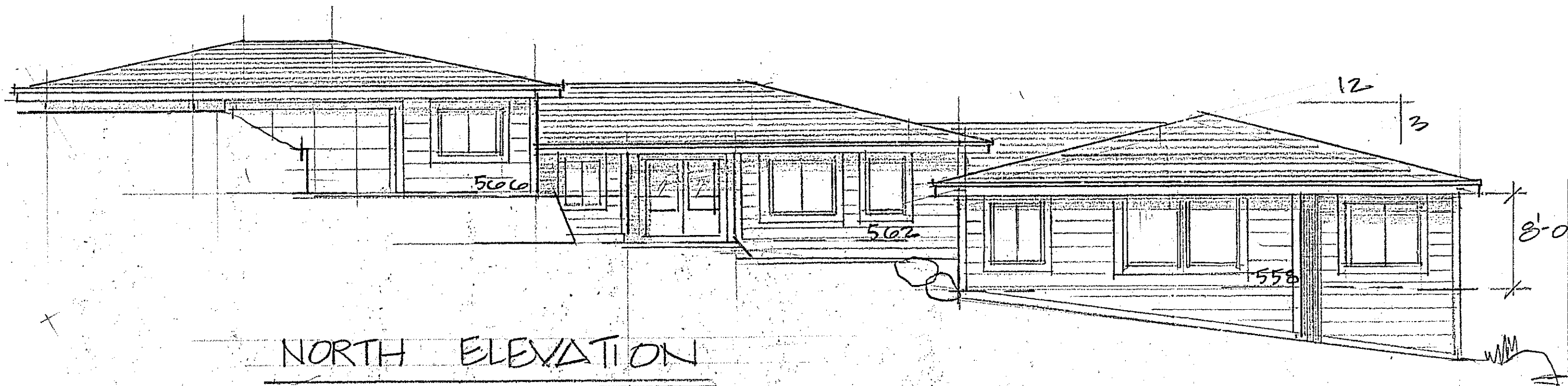

NORTH ELEVATION

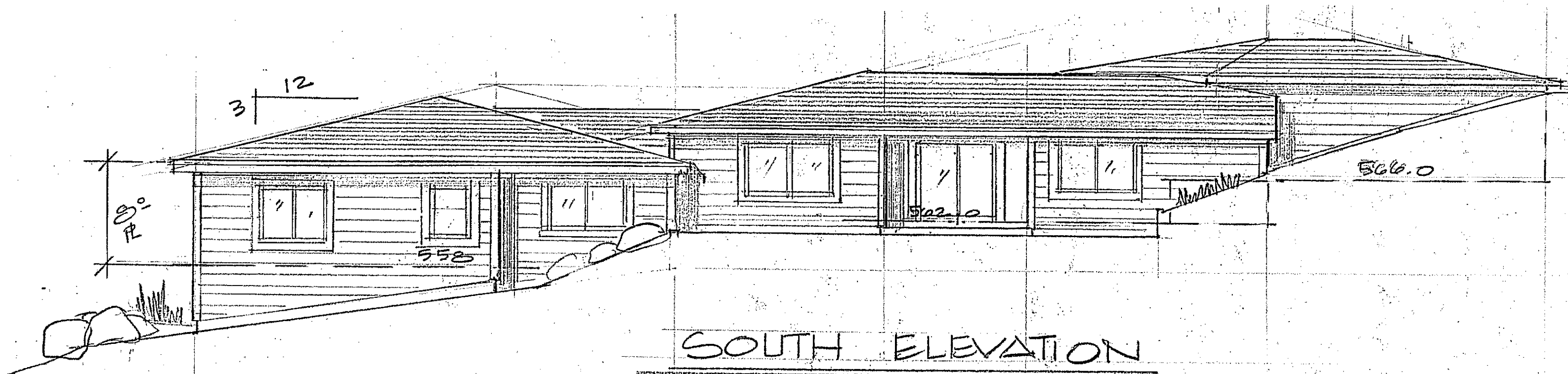
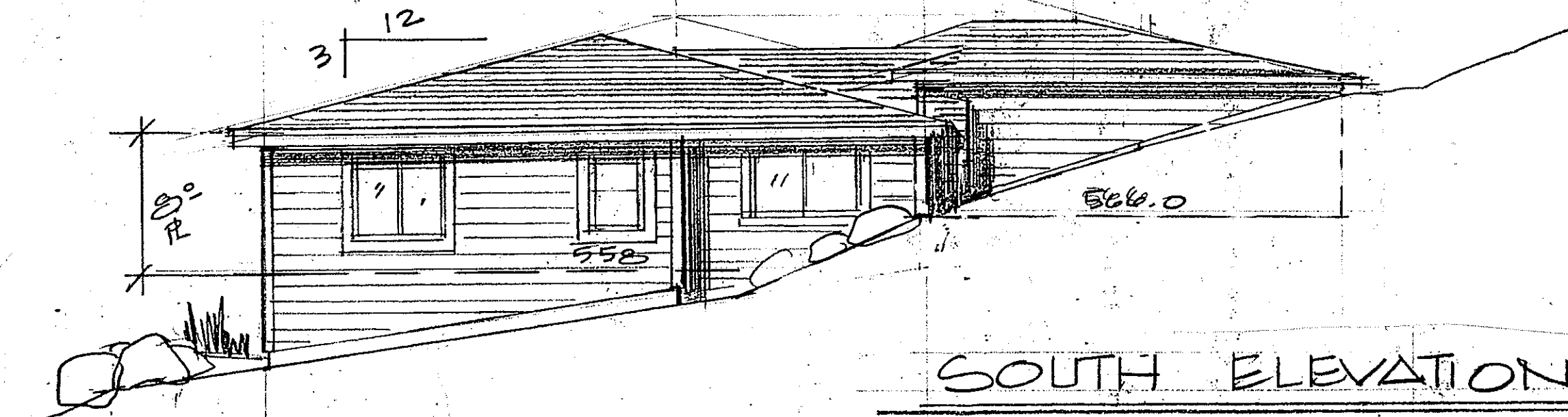

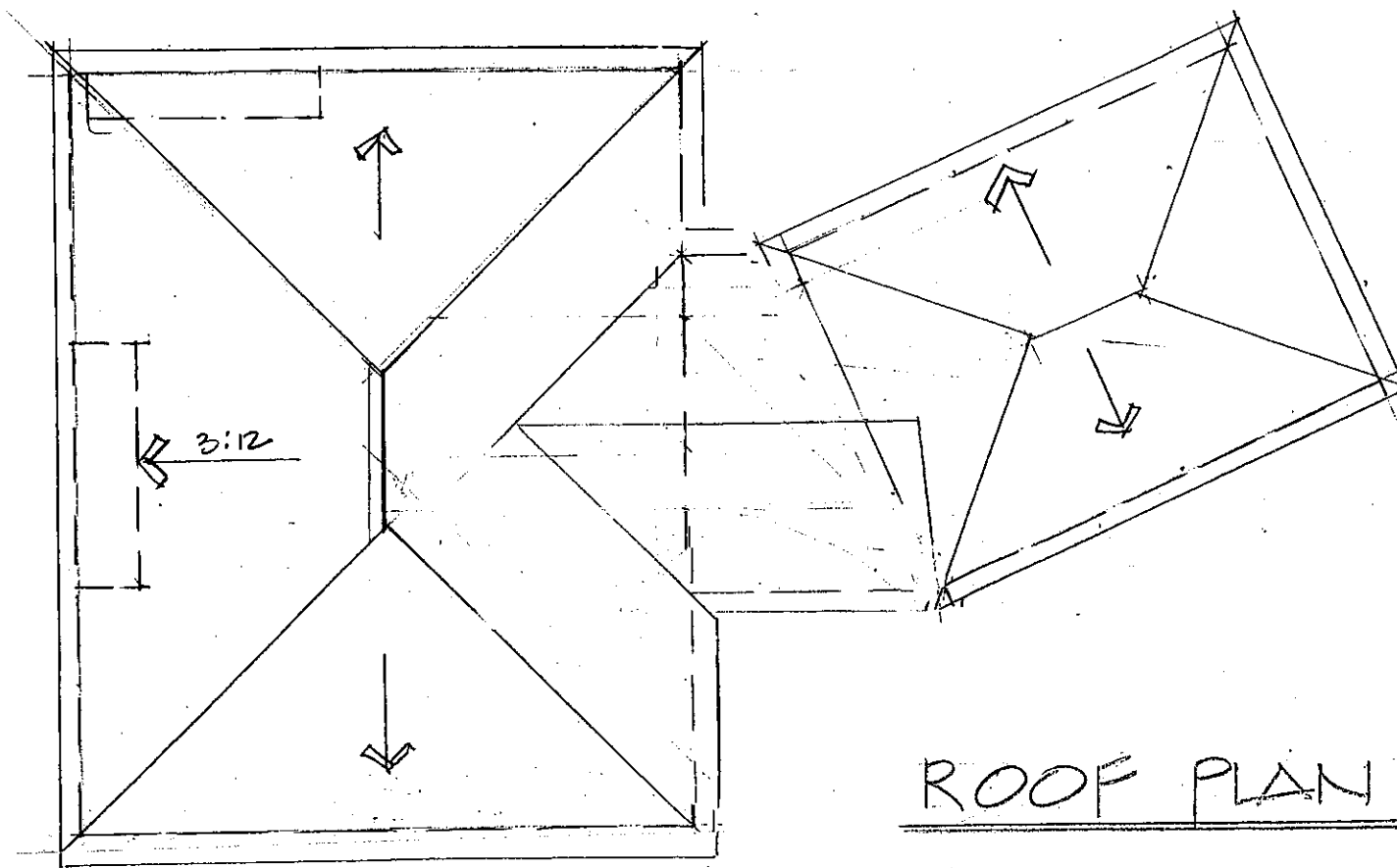

ROOF PLAN

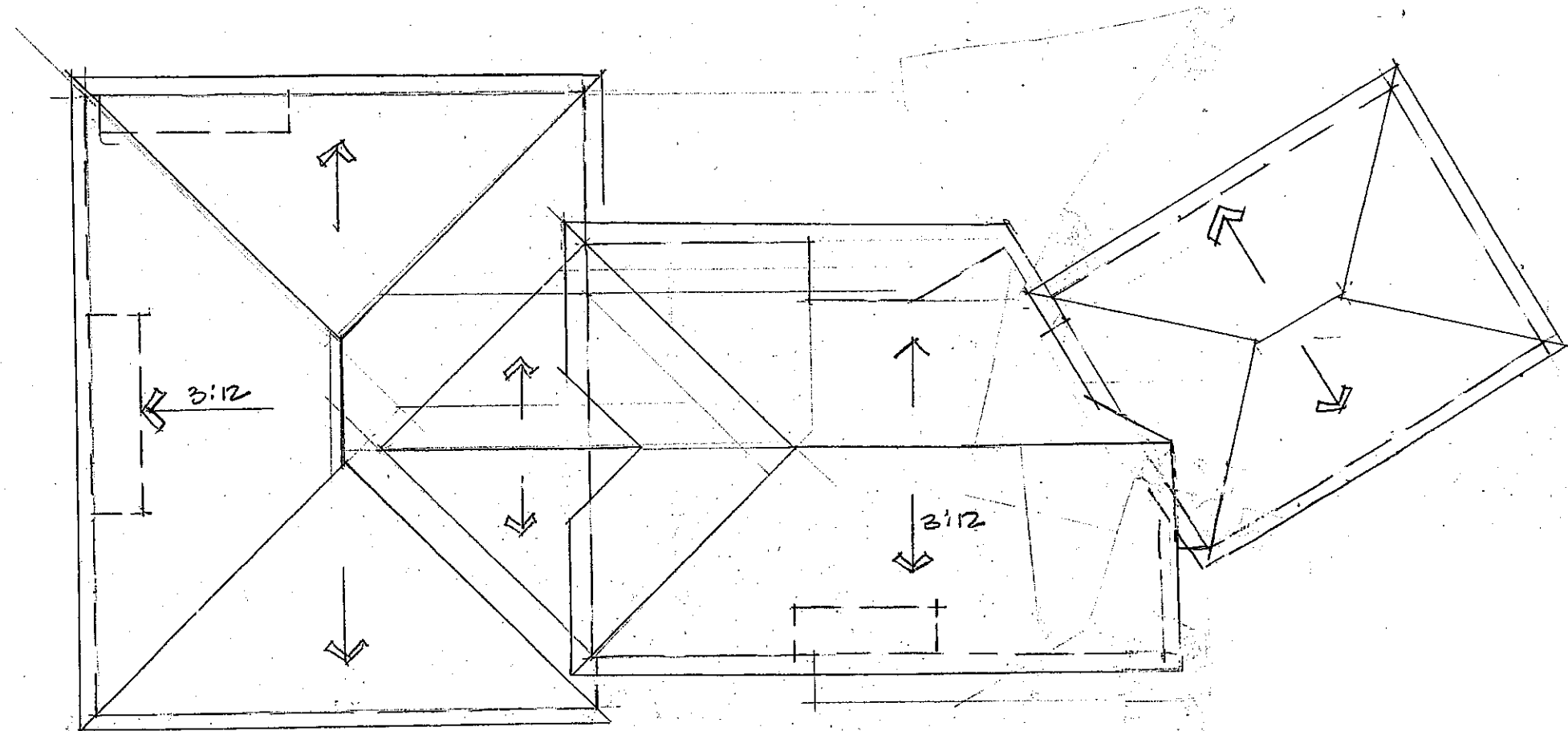

ROOF PLAN

